



VW Caddy 2015-

Art. 840629

Põhjakaitses | Skid plate | Защита картера | Motorschutz



- | | |
|--|---|
| 1. Põhjakaitses / skid plate / защита картера / Motorschutz | 1 |
| 2. Kronstein / bracket / кронштейн / Konsole | 1 |
| 3. Kronstein / bracket / кронштейн / Konsole | 1 |
| 4. Lülilik / plate with nut / пластина с гайкой /
Platte mit Mutter | 2 |
| 5. T-polt / T-bolt / T-болт / T-bolzen | 2 |
| 6. Puks / bushing / букса / Buchse | 2 |
| 7. Polt / bolt / болт / Bolzen M8x40 | 2 |
| 8. Polt / bolt / болт / Bolzen M8x30 | 2 |
| 9. Mutter / nut / гайка / Mutter M10 | 2 |
| 10. Seib / washer / шайба / Scheibe 10,5x20x2,5 | 2 |
| 11. Seib / washer / шайба / Scheibe 8,4x24x2 | 4 |
| 12. Vedruseib / spring washer / пружинная шайба /
Federnscheibe A10 | 2 |
| 13. Vedruseib / spring washer / пружинная шайба /
Federnscheibe A8 | 4 |

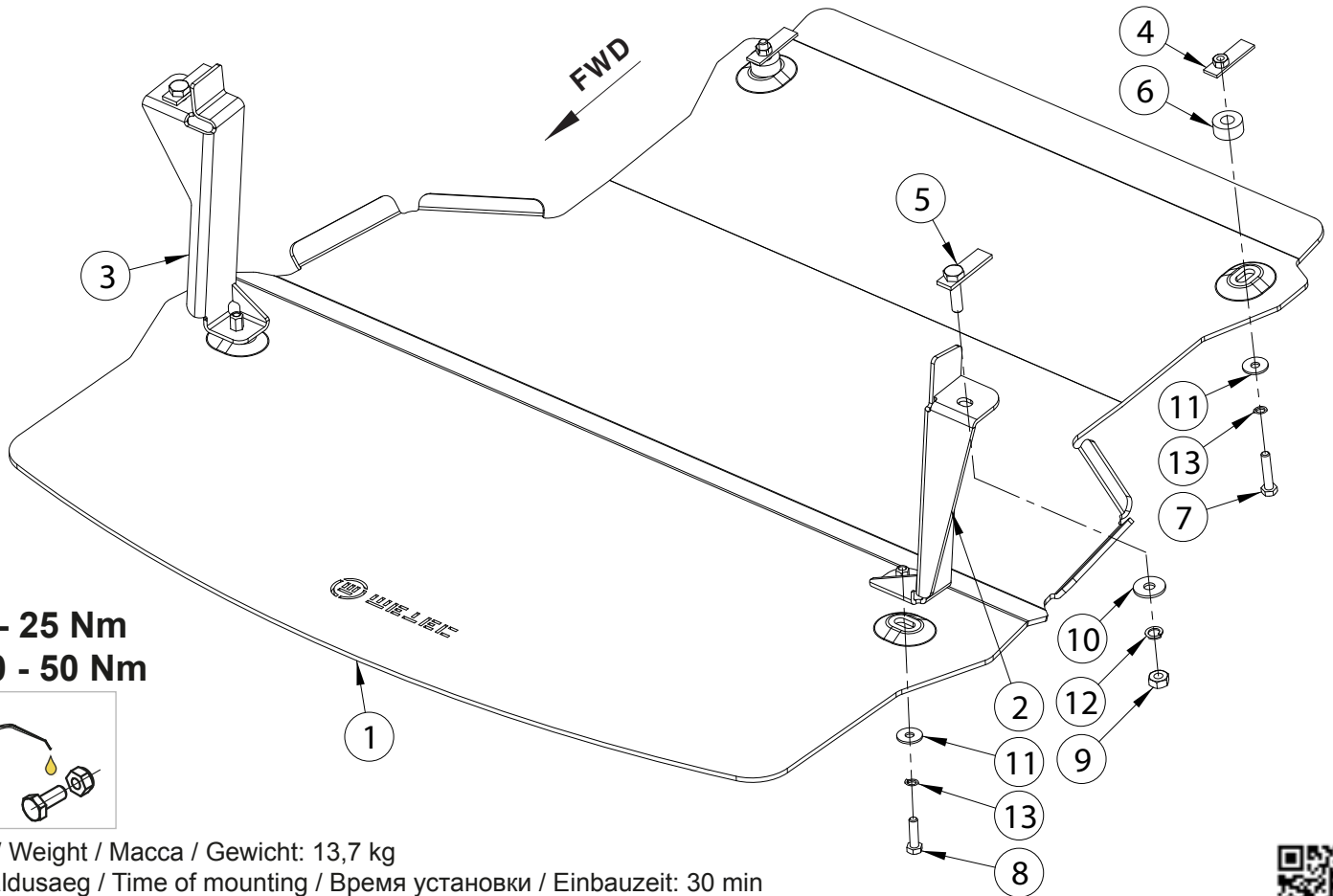

M8 - 25 Nm
M10 - 50 Nm

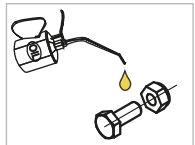

Kaal / Weight / Масса / Gewicht: 13,7 kg

Paigaldusaeg / Time of mounting / Время установки / Einbauzeit: 30 min

Vajalikud tööriistad / Required Tools / Необходимые инструменты / Benötigte Werkzeuge

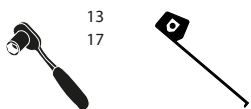

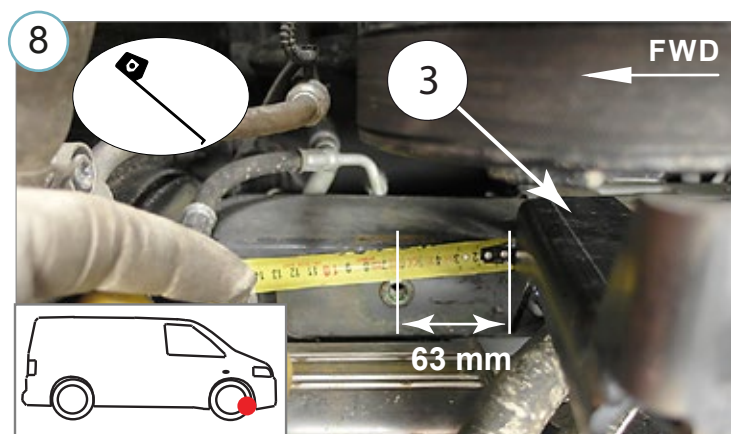
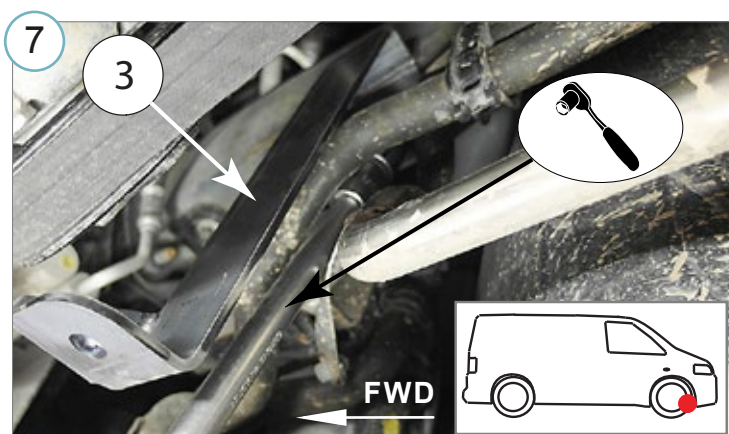
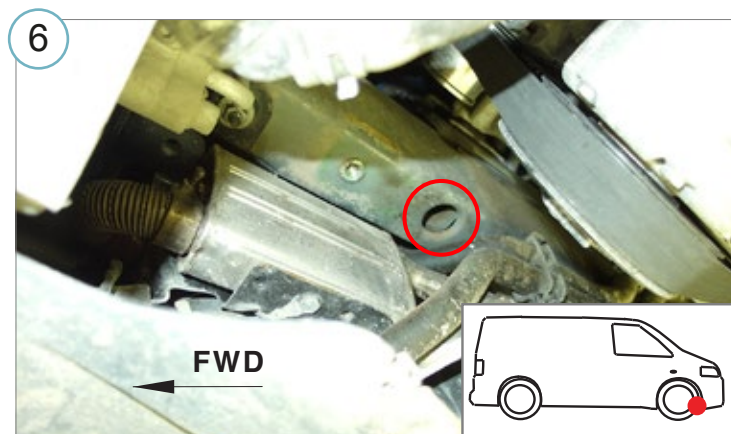
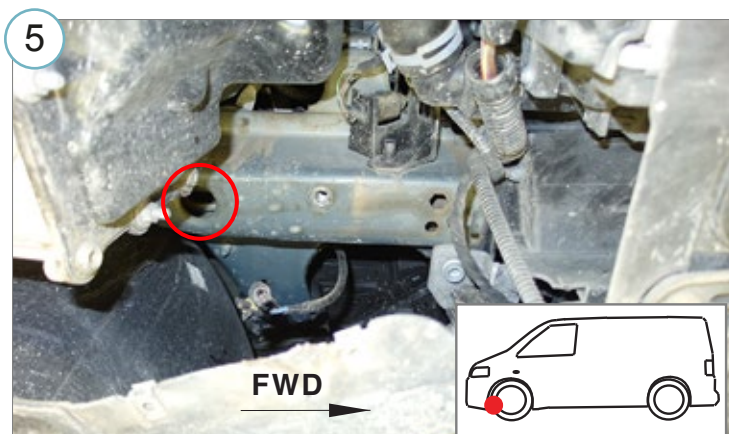
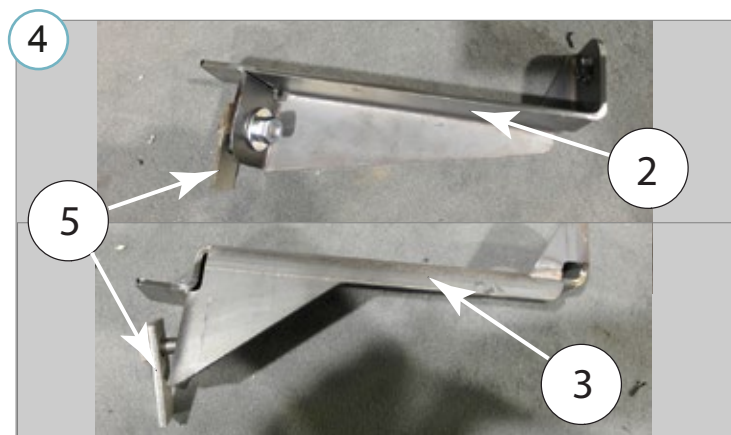
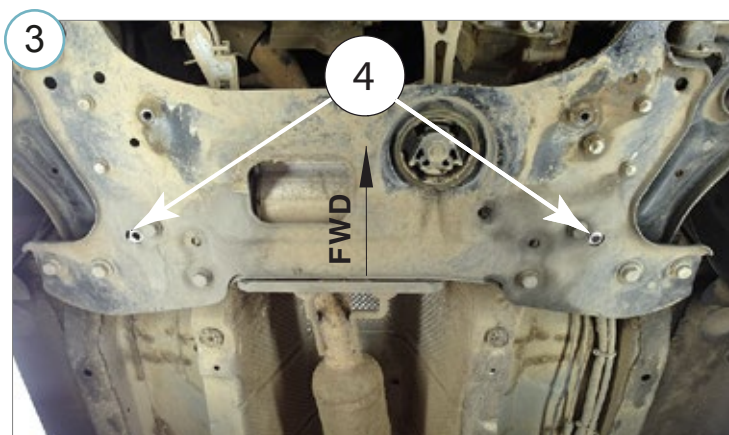
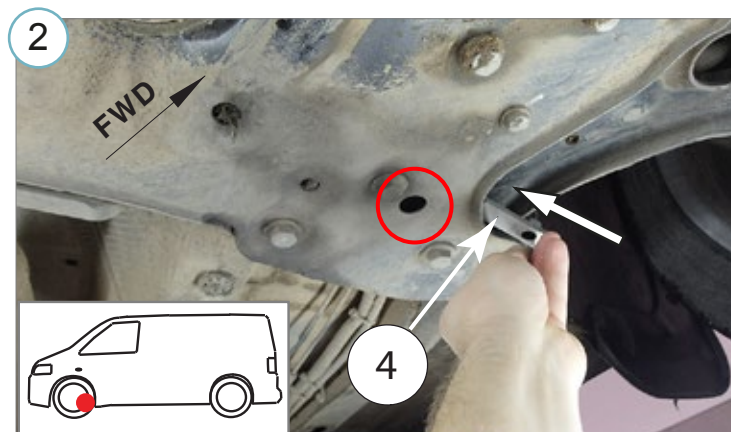
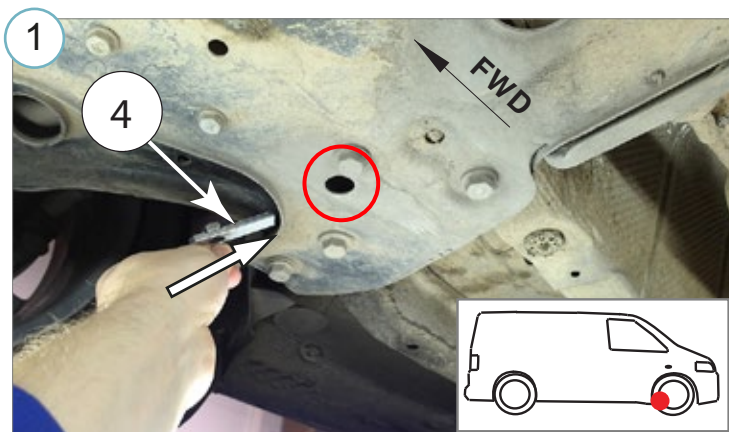

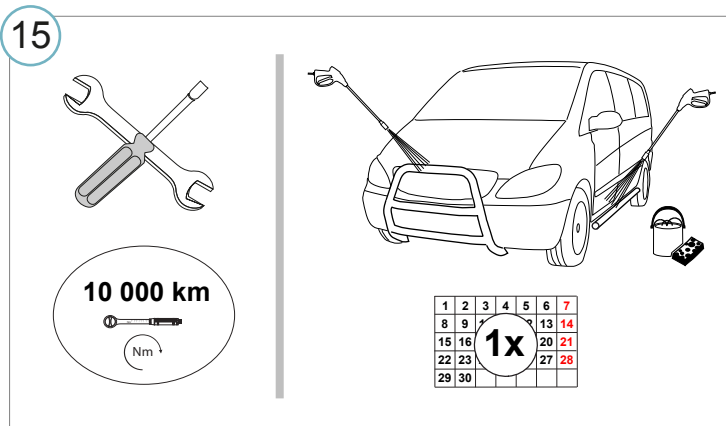
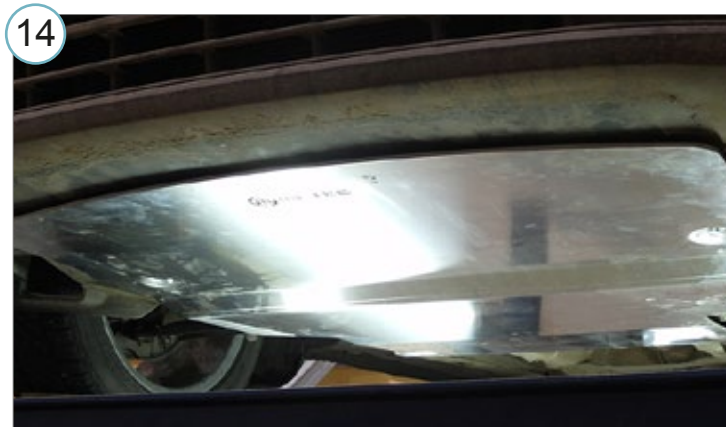
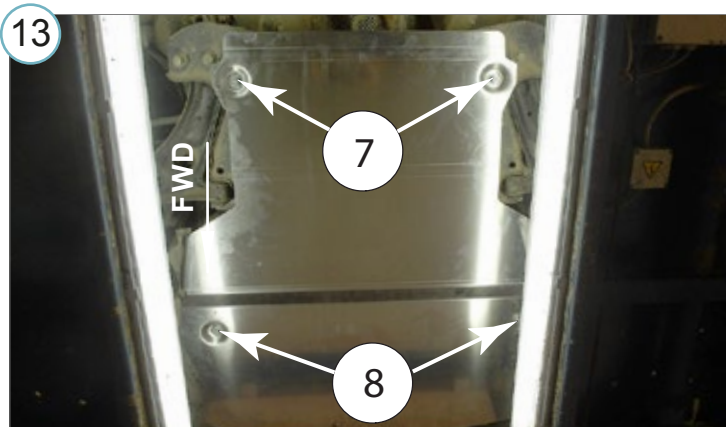
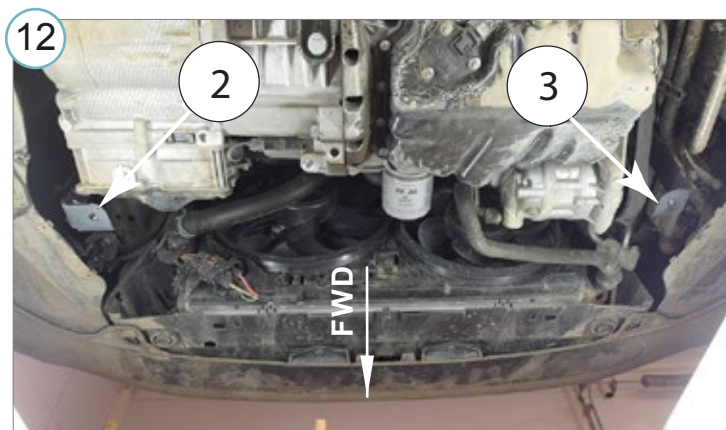
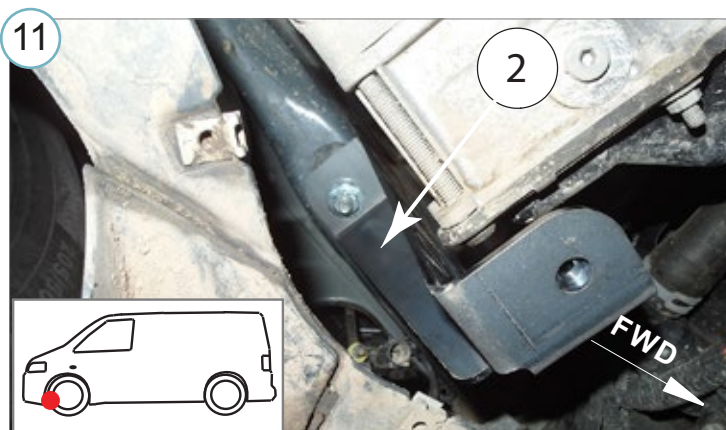
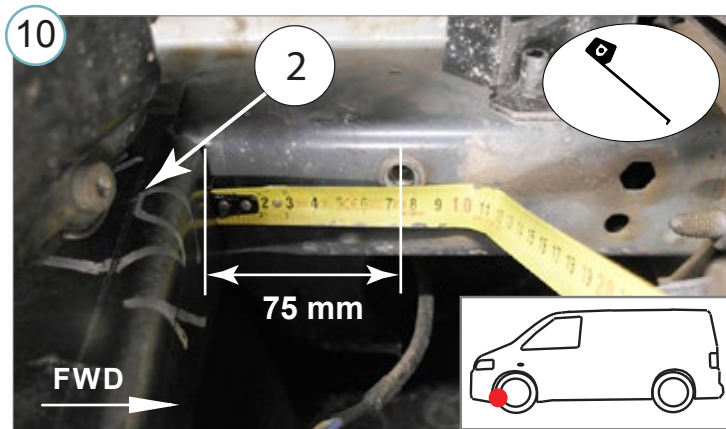
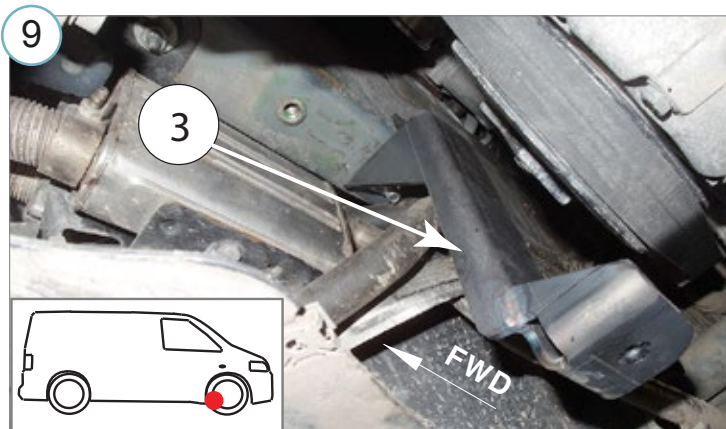

- Kui METEC toode ei vasta Teie ootustele või kui on tegemist toote ebapiisava kvaliteediga, siis pretensioonid esitada lehel www.metec.ee
- If the METEC product does not meet Your expectations or if it is a product of insufficient quality, then you can submit a claim at www.metec.ee
- Если METEC продукт не соответствует Вашим ожиданиям или это продукт недостаточного качества, то претензию предъявить можно на сайте www.metec.ee
- Wenn METEC Produkt nicht Ihren Erwartungen entspricht oder wenn es um Qualitätsmängel geht, dann bitte die Ansprüche auf Seite www.metec.ee einreichen